



Measures

Technology

Values

Innovation

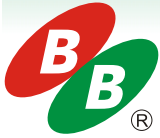

## VRLA Rechargeable Battery

# BC12-12 (BC12-12FR)

### FEATURES

- Maintenance free(no water topping-up required)
- No free acid(Non-spillable battery)
- Can be used in any orientation(excluding used inverted)
- Absorbent Glass Mat technology for efficient gas recombination
- Its design life is up to 5 years in floating application

### APPLICATION

- UPS
- Laboratory Equipment
- Power Packs
- Toy-Cars
- Fishing Lights



### SPECIFICATIONS

Nominal Voltage	12V	
Nominal Capacity	20 Hour Rate (600mA, 10.5V)	12.0 Ah
	10 Hour Rate (1140mA, 10.5V)	11.4 Ah
	5 Hour Rate (2040mA, 10.5V)	10.2 Ah
	1 Hour Rate (7200mA, 9.30V)	7.20 Ah
Approx. Weight	3350g(7.39lbs.)	
Terminals	T2 (Faston Tab 250)	
Max. Discharge Current	180 A (5 sec.)	
Max. Charge Current	3.60 A	
Operating Temperature Range	Charge	0°C~40°C(32°F~104°F)
	Discharge	-20°C~50°C(-4°F~122°F)
	Storage	-20°C~40°C(-4°F~104°F)
Self Discharge	< 3% per month (25°C)	
Internal Resistance	≤18mΩ (Fully Charged )	

### CONTAINER MATERIAL

- BC12-12:  
ABS: UL 94-HB (Dark gray color)
- BC12-12FR:  
ABS: UL 94-V0 (Light gray color)

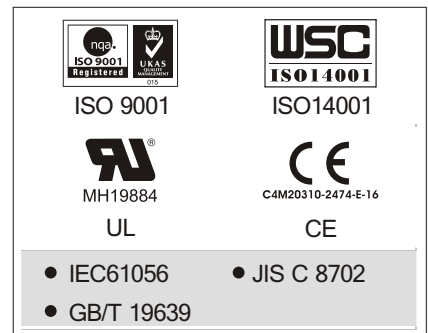

### OUTER DIMENSIONS mm(inch)

Length (L)	Width (W)	Container Height (H)	Total Height (TH)
151±1.5(5.94±0.06)	98±1.5(3.86±0.06)	94±1.5(3.70±0.06)	98±2.0(3.86±0.08)

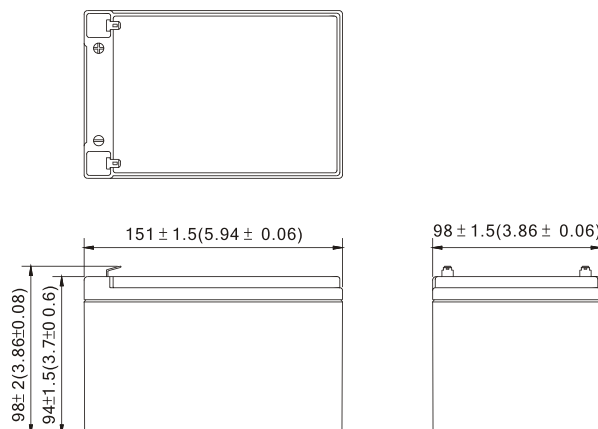

### TERMINAL TYPE

- Terminal T2

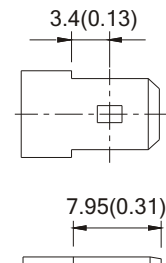

**BC12-12 (BC12-12FR) discharge characteristics (25°C/77°F)**

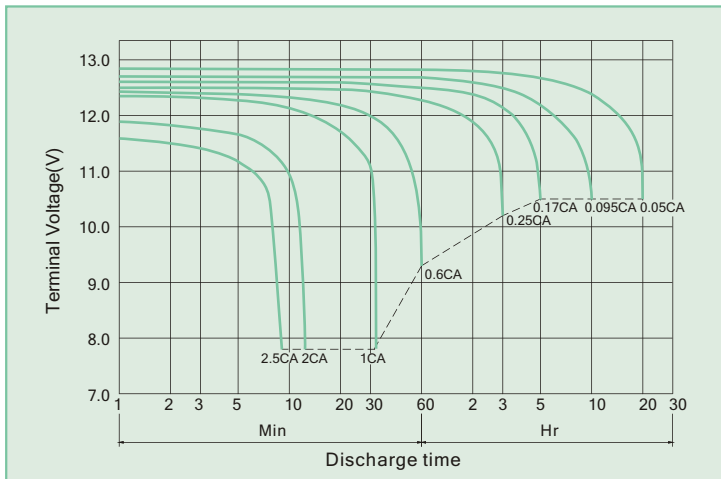

**Battery Charging Characteristics**

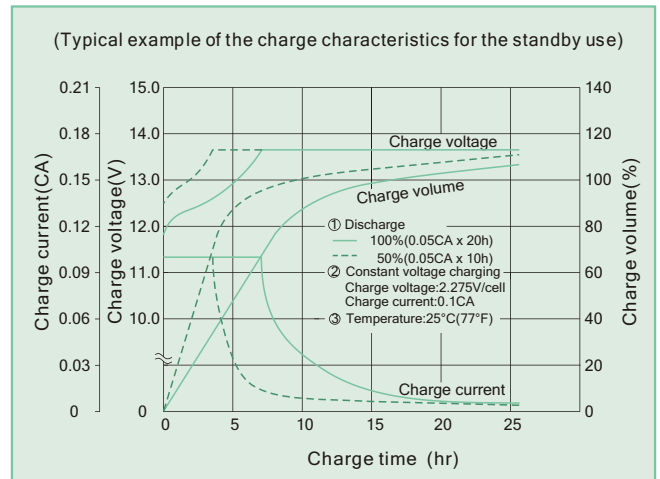

**Charging Procedure**

Application	Charging method	Charging Voltage at 25°C (V/cell)	Temperature compensation coefficient of charging voltage (mV/°C/cell)	Max. charging current (CA)	Charging time 0.1CA, 25°C (h)		Temp (°C)
					100% discharge	50% discharge	
For standby power Source	Constant voltage & Constant current charging (with current restriction)	2.25~2.30	-3	0.3	24	20	0~40 (32~104°F)
For cycle service		2.40~2.50	-4	0.3	16	10	

**Effect Of Temperature On Long Term Float Life**

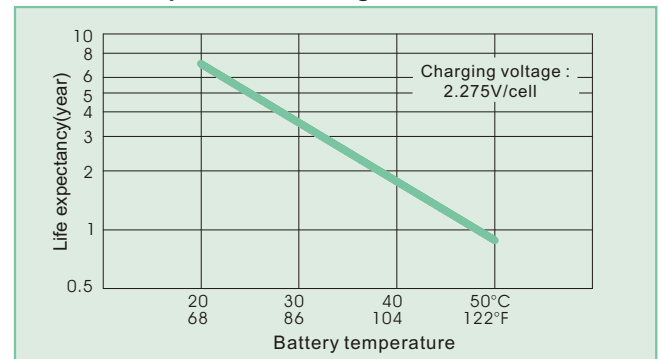

**Constant power discharge characteristics at 25 °C/77 °F Unit: W**

F.V. (V/cell) \ Discharge Time	5 Min	10 Min	15 Min	30 Min	1 Hr	3 Hr	5 Hr	10 Hr	20 Hr
1.80V	433.9	319.4	256.0	152.3	87.3	35.0	24.1	13.48	7.09
1.75V	502.2	346.0	267.7	158.1	90.0	35.7	24.5	13.68	7.20
1.70V	533.6	358.5	276.0	161.7	91.6	36.0	24.6	13.75	7.24
1.65V	557.5	367.1	282.4	164.0	92.7	36.3	24.7	13.79	7.26
1.60V	576.0	374.4	288.0	165.6	93.6	36.5	24.8	13.79	7.26

**Constant current discharge characteristics at 25 °C/77 °F Unit: A**

F.V. (V/cell) \ Discharge Time	5 Min	10 Min	15 Min	30 Min	1 Hr	3 Hr	5 Hr	10 Hr	20 Hr
1.80V	39.09	28.12	22.26	12.91	7.34	2.91	2.01	1.123	0.591
1.75V	46.07	30.46	23.28	13.40	7.56	2.97	2.04	1.140	0.600
1.70V	48.95	31.55	24.00	13.70	7.70	3.00	2.05	1.146	0.603
1.65V	51.15	32.31	24.55	13.89	7.79	3.02	2.06	1.149	0.605
1.60V	52.84	32.96	25.04	14.03	7.87	3.04	2.06	1.149	0.605

All data shall be changed without prior notice, BB reserves the right to explain and update the information contained hereinto.

Trial A/5 REV. Mar. 2011

**USA:**  
B&B BATTERY(USA) INC.  
6415 RANDOLPH ST.COMMERCE, CA,90040 U.S.A.  
TEL:1-323-278-1900.1-800-278-8599  
FAX:1-323-278-1268  
E-Mail:sales@bb-battery.com

**CHINA FACTORY:**  
B.B. BATTERY CO., LTD.  
CHENG DONG TRIAL AREA,HUANG GANG,  
RAOPING, GUANG DONG,CHINA,515700  
TEL:86-768-7601001-2  
FAX:86-768-7601469  
E-Mail:maggy@bb-battery.com

**EUROPE:**  
B&B BATTERY(EUROPE) B.V.  
SUITE 8, HAAKSBERGWEG 33, 1101  
BP AMSTERDAM, THE NETHERLANDS  
TEL: 31-30-3200190  
MOBILE: 886-933896989  
E-Mail: gary@bb-battery.com

**HONG KONG:**  
B&B BATTERY(Hong Kong) Co.  
TEL:852-2311-4918  
FAX:852-2739-1182  
E-Mail:bbhk@hkstar.com

**JAPAN:**  
B&B BATTERY(JAPAN) CO., LTD.  
1375-11 NARAHARA-MACHI,HACHIOJI,  
TOKYO 193-0803,JAPAN.  
TEL:81-426-25-6375  
FAX:81-426-25-6375  
E-Mail:miyata@bb-battery.com

**TAIWAN:**  
B.B. BATTERY(TAIWAN) CO., LTD.  
TEL:886-6-502-5150  
FAX:886-6-589-8087  
E-Mail:kevin@bb-battery.com